



The Scottish
Government

Accredited Construction Details (Scotland) 2010

For the limitation of thermal bridging
and air infiltration in low and
medium rise domestic buildings

Introduction & Principles

Issued in support of '[Junction Details, Parts 1 to 5](#)'

October 2010
v1.2

Produced by the Buildings Standards Division

First published: October 2010

Version 1.2

Document Version Control

Title: ACCREDITED CONSTRUCTION DETAILS (SCOTLAND) 2010 for the limitation of thermal bridging and air infiltration in low and medium rise domestic buildings - INTRODUCTION & PRINCIPLES

Purpose: The Accredited Construction Details document, which comprises of this section and five other parts, is produced to assist designers, verifiers and site operatives in the delivery of buildings which limit heat loss from linear thermal bridging and uncontrolled infiltration. This section outlines issues and principles to be applied if the document, as a whole, is to be used to support compliance with building regulations.

Version	Date	Notes
1.0	October 2010	Initial issue of comprehensively updated document, in support of the 2010 revision to building regulations.
1.1	February 2011	Appendix 3 values added (p.26); amended text on VCLs (page 21); minor general editorial corrections within text
1.2	June 2011	Addition of text on use of different sources of data in calculating H_{tb} (page 7); Appendix 3 values updated for steel frame (p.26)

1. Introduction	1
Status of this document	1
Background	1
2. Purpose of Document	2
Purpose of Document	2
Format	2
Other issues	2
3. Limitations on use	3
Construction details	3
Use of cited psi values	3
Other sources of calculated psi values	3
4. Limiting thermal bridging and air infiltration	5
Thermal bridging	5
Air infiltration	5
5. The importance of junction detailing	6
Heat loss arising through linear thermal bridges	7
Heat loss arising through uncontrolled infiltration	7
6. Design principles when limiting heat loss and infiltration	8
Maintaining thermal continuity	8
Minimising thermal bridging	8
Condensation risk	9
Reducing uncontrolled infiltration	10
7. Design principles – junctions in framed construction	12
8. Design principles – junctions in masonry construction	14
9. Design to limit infiltration and interstitial condensation	16
Introduction	16
Design strategy – general	16
Design strategy – masonry construction	17
Design strategy – timber or metal frame	17
Specific comment on particular building components	18
Workmanship	19
Properties of differing insulation materials	20
Ventilation of cavities	20
Low emissivity materials	21
Types of building membrane	21
Appendix 1 – design & construction checklists	23
Appendix 2 – values used in psi calculations	25
Appendix 3 – temperature factor for details	26
Appendix 4 – further reading	27

1. INTRODUCTION

Status of this document

This document provides guidance on one way to meet some of the requirements of the functional standards set out in Regulation 9 of the Building (Scotland) Regulations 2004, as amended. There is however no need to follow the guidance in this document, as there are other ways of meeting the functional standards. The [Technical Handbooks](#), which give guidance on ways of complying with the building regulations, are available to download from the Building Standards Division's website at www.scotland.gov.uk/bsd.

Background

Achieving current energy performance standards for new construction work will generally mean that buildings are more highly insulated. Buildings will have improved heating system efficiencies and need a consistently good level of design and construction to ensure that heat losses from uncontrolled air infiltration and through junctions in the building fabric are minimised.

The guidance and examples in this document are intended to assist in the understanding and application of the design and construction principles needed to reduce both uncontrolled infiltration and linear thermal bridging at junctions between building elements.

The information and details in this document do not endeavour to achieve specific or absolute levels of air infiltration but, they can limit air infiltration to an acceptable level without the need to consider alternative ventilation strategies for dwellings and other domestic-scale buildings. Designers looking to achieve very low infiltration rates ($<5\text{m}^3/\text{m}^2\text{h}$) should therefore make reference to further good practice information available elsewhere.

When assessing heat loss at junctions, if the principles and performance of specified elements within a particular junction example are followed, the cited ψ (psi) value for that junction may be used in the calculation of building heat loss within [SAP 2009](#) or [SBEM/NCM](#) (other sources of such values are available, as discussed in chapter 3).

The details have been developed to minimise the risk of both surface and interstitial condensation. They also take into account some aspects of construction sequencing and can be built using construction methods and skills currently available.

2. PURPOSE OF DOCUMENT

Purpose of Document

The Accredited Construction Details (ACDs) have been revised and expanded to illustrate principles relevant to reducing fabric heat loss in new buildings constructed to meet the 2010 Scottish building standards. The purpose of the document is to assist designers, verifiers and site operatives in the delivery of buildings which limit heat loss from linear thermal bridging and uncontrolled air infiltration.

The document provides information on:

- ready means to manage thermal loss, with a particular focus on thermal bridging at junctions (to reduce energy requirements);
- limiting uncontrolled air infiltration (to reduce energy requirements);
- avoiding interstitial condensation (which can damage construction); and
- avoiding surface condensation (which can lead to mould growth and endanger health).

Format

There are six parts to the document. This introduction outlines how this resource can be used and discusses the principles and practices that can assist in limiting heat loss.

Parts 1 to 5 offer examples of common construction situations where these principles are applied. The common factors which are illustrated in each example junction detail are:

- the position and continuity of insulation and the avoidance of bridging elements (to limit thermal bridging);
- the position and the different performance characteristics of the air and vapour barriers (to manage air and vapour movement and to prevent water entering the building);
- the position and extent of ventilation of cavities (to control condensation);
- the position and type of cavity closers/barriers to limit air movement, reduce thermal transfer and to provide fire resistance.

Each detail section ([Parts 1 to 5](#)) must be read in conjunction with this introduction

Other issues

There are a wider range of building performance issues, which should be considered by parties involved in the design and construction process. These are not directly illustrated by these details but include:

- structural integrity;
- fire resistance and flame spread;
- ventilation of occupied spaces;
- damp-proofing arrangements;
- airborne and impact noise (including flanking sound); and
- thermal performance of elements (U-values).

3. LIMITATIONS ON USE

This document provides supplementary information in support of issues identified within the [Technical Handbooks](#). It is intended to provide information that will assist designers and contractors in achieving the level of performance presented in these documents in a range of common construction scenarios.

Construction details

Details provided in Parts 1 to 5 illustrate principles of construction in a variety of common junction situations across a range of common constructions. They are generic in nature and for this reason they are not dimensioned, nor drawn to scale. It should be noted that only one of many permutations of thermal insulation is shown in each example.

The examples are shown with U-values which meet or improve upon those used for target setting within clause 6.1.2 of the Domestic Technical Handbook.

Each detail section ([Parts 1 to 5](#)) must be read in conjunction with this introduction

All examples are relevant to construction of domestic-type buildings up to six storeys high, and are designed to be buildable with normal, current site practice. They may however require different sequencing of operations in some cases.

- Part 1 - Full Fill Masonry Junction Details
- Part 2 - Partial Fill Masonry Junction Details
- Part 3 - Timber Frame Junction Details
- Part 4 - Metal Frame Junction Details
- Part 5 - Additional Common Junction Details

The example details are not intended as, and should not be used as, standard details for construction.

Instead, the principles and key element specification within an example should be applied by the designer where detailing similar junction or construction situations. Illustration of these issues will assist the designer, verifier and builder to each assess whether both design proposals and work on site will deliver the intended levels of performance.

Use of cited psi values

The psi values cited for each example detail may be used in calculation of building heat loss where proposals by the designer address both the principles of construction set out in this part of the document and incorporate the key element specification issues identified in the relevant example within Parts 1 to 5.

Only a limited range of common examples can be given, which should be of use in the majority of projects. It is expected that designers may also choose to use other sources of information to assist in addressing the performance issues covered by this document.

Other sources of calculated psi values

Other sources of published psi values will be available and it is expected that sources of such information will become more widespread as manufacturers and industry bodies produce information to support products and systems.

It is also expected that individuals and organisations will also wish to have the facility to calculate bespoke psi values. The following outlines initial expectations necessary to validate the use of such sources.

The production of psi values for standard details or constructions should be carried out only where there is a demonstrable ongoing competence in such calculations. Assessment should be carried out by, or independently verified by, a notified body or UKAS accredited organisation which has a declared specialism in this field.

In any document containing such calculated values, the details of the individual or organisation providing the calculated values should be given. Values should only be published where a satisfactory assessment of surface condensation risk is made, with the temperature factor and any other relevant data also made available.

There are two issues which must be addressed – initial and ongoing competence.

- **Initial competence** - can be demonstrated by appropriate training and successful assessment. Training should focus on the guidance given in BR 497- 'Conventions for Calculating Linear Thermal Transmittance and Temperature Factors' and also on the correct and consistent application of principles using identified software tools.
- **Ongoing competence** –as thermal modelling of junctions remains a specialised activity, individuals, including those within notified bodies or UKAS accredited organisations, should still undertake specialised training, with their calculations and process subject to periodic audit to provide both quality assurance of output and evidence of ongoing competence.

It is expected that independent accreditation schemes for thermal modelling of junction heat loss will be developed as interest in this area increases. This document will be revised periodically to make reference to such schemes. This may offer individual construction professionals, who wish to assess their own work or offer calculation services to others, a means of demonstrating ongoing competence in this field.

4. LIMITING THERMAL BRIDGING & AIR INFILTRATION

In any building where the inside is warmer than the outside (or vice versa), heat will gradually flow through building elements, from the warmer to the colder side. The rate at which this happens varies depending upon the capacity of materials used to transfer heat and the thickness of the materials forming the building insulation envelope - the walls, floors, roof and openings.

It is now common to rely upon layered construction which includes insulation elements with a very low thermal conductivity. Key to the success of such constructions is use of insulation in the correct locations, installed correctly so that there is continuity of insulating elements.

Insulation should be tightly fitted against and between construction elements, to eliminate gaps and prevent slump or movement that could degrade performance. As fabric insulation standards are improved in response to changing demands (including building regulations), there is an increasing need to understand both heat transfer mechanisms and how to design and construct building elements to reduce different forms of heat loss.

Thermal Bridging

Any building element that passes through an insulation layer creates a risk of thermal bridging. The greater the area, continuity and conductivity of such elements, the greater the effect on overall performance and potential for related risks. Thermal bridging results in areas where heat passes through the construction at a more rapid rate than adjoining constructions which, aside from increasing heat loss, can lower the surface temperature at those locations. Low surface temperature can lead to both surface and interstitial condensation, with the potential for mould growth and degradation of fabric if the conditions persist and there is not adequate ventilation present.

There are two types of thermal bridging:

- Repeating thermal bridges e.g. timber joists or rafters; and
- Non-repeating thermal bridges occurring at the junctions where elements join.

This document sets out good practice on the latter - how to limit heat loss occurring as a result of non-repeating thermal bridging at junctions between building elements and around openings.

Air Infiltration

Uncontrolled air infiltration that occurs through the building insulation envelope also affects how well insulation performs. This is a different issue to that of providing controlled ventilation into rooms or ventilating cavities in constructions to remove condensation vapour. Ventilation is used to maintain air quality, remove odours, indoor air pollution and condensation from within a building. Uncontrolled air infiltration allows colder air into warm spaces (and vice versa) and will increase heat loss, which, if not addressed can significantly reduce the effectiveness of the insulation envelope. For example, the difference between a well sealed building and the assumed default value within SAP ($15 \text{ m}^3/\text{m}^2\text{h}$) can account for anything up to 20% of fabric heat loss.

It is recognised that, whilst it is generally not practicable to design to a specific level of infiltration, adoption of recognised good practice across a range of common constructions can, if applied correctly, result in levels of performance within a relatively small range.

In determining the design level of infiltration for a building, the designer should therefore be satisfied that any stated performance can reasonably be achieved, both in terms of the specification and detailing at design stage and also that the methods specified can be met effectively on site by site operatives. Accordingly, knowledge of the skills and 'track record' of a contractor and communication of what is required in such matters can be of assistance.

5. THE IMPORTANCE OF JUNCTION DETAILING

Buildings lose energy to the outside through the fabric of the building and by controlled and uncontrolled ventilation. From the point of view of energy and moisture performance, building fabric can be considered to consist of two sets of elements:

1. Walls, roof and ground floor and the windows and doors within them. Heat loss is quantified by the U-value and the area of the component. If well constructed, elements should limit both unwanted ventilation of the building and air leakage into the structure. Methods to calculate the U-value are summarised in BR 443 – ‘Conventions for U-value calculations’ and specified in BS EN ISO 6946¹, and to calculate the risk of surface and interstitial condensation in BS EN ISO 13788. Both methods are simple and are implemented in commercially available software packages, which can be used by anyone with knowledge of construction practice; and
2. Junctions where the walls meet the floors and roof, around the doors and windows and where services enter the building. These junctions between elements contain a number of features that make their heat and moisture performance significantly different from the walls:
 - the geometry is complex so that heat and moisture flow will not simply be straight through the fabric but influenced by two or three dimensional effects;
 - at junctions like corners, where two external walls meet or the eaves of a roof, the area of the external surface is greater than the internal surface, giving greater potential for heat loss;
 - junctions may contain structural elements (e.g. window or door lintels) like steel or concrete, which have higher thermal conductivity than surrounding materials; and
 - where different materials meet, there will be discontinuities, which may lead to gaps through which air can move.

Location of typical junctions

1. Roof eaves
2. Roof gable
3. Wall/ground floor
4. Window/door lintel
5. Window jamb
6. Window sill
7. Corner
8. Door threshold
9. Internal corner
10. Intermediate floor

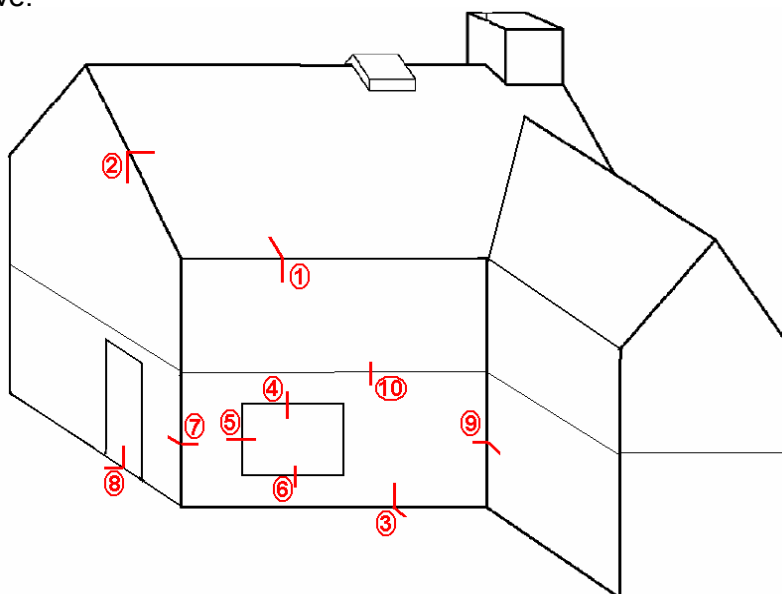

Calculations of heat loss through junctions are complex, using a process set out in BS EN ISO 10211, and requiring sophisticated software, which can only be used by trained personnel (see chapter 3 for commentary on training).

¹ See also BS EN ISO 13370 for floors adjacent to the ground and basements; BS EN ISO 10077-1 or 10077-2: 2003 for windows, doors and rooflights; and BS EN ISO 12567-2 for rooflights and other projecting windows

Heat loss arising through linear thermal bridges

In new, more energy efficient buildings, with improved planar U-values, the proportion of heat loss that can occur through linear thermal bridges at poorly detailed junctions is higher. It is, therefore, important to minimise such losses through detailing and construction of junctions to minimise pathways for heat loss. The need to assess such losses is explained in guidance to standard 6.2 within the [Technical Handbooks](#) under 'Limiting heat loss through thermal bridging' (clause 6.2.3 domestic and 6.2.5 non-domestic).

Heat loss at junctions is defined by linear thermal transmittance, Ψ (psi, measured in W/m·K). This is the rate of heat flow per degree per unit length of the bridge, a loss that is not accounted for in the calculated U-value of the planar building elements forming a junction.

The transmission heat loss coefficient arising from linear thermal bridges in a building, (H_{TB}), is the sum of the products of each junction Ψ -value and length, expressed as:

$$H_{TB} = \Sigma(l \times \Psi) \quad \text{where } l = \text{the length of the thermal bridge in metres} \\ \text{to which a particular } \Psi\text{-value applies}$$

It is this value, combined with the overall heat loss through planar elements which gives the overall fabric heat loss for a building (excluding losses through infiltration).

Appendix K in [SAP 2009](#) identifies a series of 23 possible junction conditions which, where present within a dwelling, should be assessed to calculate the transmission heat transfer coefficient (for non-domestic buildings, iSBEM defined seven key junction conditions and requires designers to identify further junctions as relevant to the building).

In calculation of H_{tb} , designers may combine data from different sources, such as from the Accredited Construction Details, manufacturer or other calculated values (where the provisions noted on page 4 of this document are met). Where other sources are unavailable, default Ψ values for individual junctions are listed within Appendix K of SAP 2009.

For further information on assessing the effect of thermal bridging at junctions and around openings in the building insulation envelope, reference should be made to the BRE publication IP 1/06 - 'Assessing the effects of thermal bridging at junctions and around openings'. A detailed explanation of the calculation method and modelling procedure may be found in BR 497 - 'Conventions for Calculating Linear Thermal Transmittance and Temperature Factors'.

Heat loss arising through uncontrolled infiltration

There are no standard methods for calculating moisture movement and air leakage at junctions. Accordingly, simplicity of detailing and consideration of how an air barrier will be constructed and maintained during site works are necessary, with building performance now commonly being verified by airtightness testing prior to completion.

General principles are discussed in the next few chapters.

6. DESIGN PRINCIPLES - LIMITING HEAT LOSS & INFILTRATION

Maintaining Thermal Continuity

As the levels of insulation increase in wall, floor and roof constructions, it becomes important to consider what happens at junctions between insulation zones. Common building materials such as timber, metal and concrete are greater conductors of heat than insulation. Breaking the continuity of insulation by using another type of material creates a point where heat loss is greater. As heat is transferred more quickly to the outside through materials with greater heat transmittance, the surface temperatures of those materials will be lower. As a result there is a greater condensation risk at these points.

The key design aim for any junction is to make sure that there isn't any single element or combination of elements that will conduct heat rapidly through the construction and also to ensure that, in addressing this issue, the potential for condensation is assessed.

At design stage, proposals should identify a continuous layer of thermal insulation around the building, within the planes which form the building insulation envelope. Consideration should be given to how continuity of insulation will be maintained at junctions between these elements and around openings and service penetrations. In detailing junctions, a designer needs also to consider the practicalities of constructing the proposed details on site.

Heat loss will always take the path of least resistance, especially at junctions of similar or differing constructions. Where major junctions occur - e.g. floor/wall and roof/wall - insulation within different elements should abut and overlap. Where this is not practical, the specification and thermal conductivity of any intermediate elements to minimise linear thermal bridging through the structure at that point should be considered.

Using the correct insulation is equally as important as making sure that the insulation zone is continuous. For example:

- Insulation that is to be laid below the floor slab or below DPC level in walls has to be rigid to bear the weight of the concrete slab finish. Additionally, it should not be capable of absorbing moisture.
- Insulation used in walls and roofs where condensation vapour is to pass through the construction must not be capable of absorbing moisture. If it does then there is a risk that moisture will be trapped within the construction, where it can reduce the performance of the insulation and provide a risk of promoting mould growth.
- In some cases, insulation can be used as a substitute for sarking board. If this option is chosen then a breather membrane may still be required in order to form some measure of weather protection to the insulation, both during construction and in the event that rain penetrates through the external finishes layer.

Minimising Thermal Bridging

This accredited details document identifies design principles applicable to typical junctions, along with the psi value for typical junctions for a range of four construction options. These psi values have been calculated using the standard thermal conductivity of materials from the BRE U-value calculator.

At design stage potential thermal bridging locations can be identified by checking if any construction elements pass through the insulation and air tightness zones. The first option is to decide if such elements can be removed or changed. It may be possible to break a bridging element into two smaller elements and introduce insulation between them. If this is not possible, consider improving the performance of the element causing the bridging.

Condensation Risk

One consequence of thermal bridging is condensation forming on cold surfaces surrounded by warmer air. If condensation forms on a surface where it is not expected or within a construction where it cannot be seen then it can result in long term problems.

If thermal bridging at junctions is not minimised to a level comparable with the improved U-values of surrounding elements, then there is a greater risk of bridging resulting in low surface temperatures and surface condensation. When combined with reduced infiltration or inadequate ventilation, which slows both evaporation and drying out, this can lead to mould growth and other problems.

Similarly, lack of control of water vapour passing into a construction where there are colder surfaces on bridging elements may result in interstitial condensation which, if in the wrong location or not relieved by ventilation within a construction, can also give rise to building defects.

To avoid this, designers should seek to maintain the continuity of thermal insulation and to minimise thermal bridging, as outlined above. The next step is to consider the vapour permeability of the proposed construction.

There are two design options to consider – use of a vapour permeable construction; or one that stops water vapour from entering the construction:

- option one requires that there is an increasing level of vapour permeability of materials from the warm side to the cold side of the construction. This permeability gradient allows water vapour to pass freely through the construction until it reaches a well ventilated zone where it can be dispersed.
- option two requires that a vapour control layer (VCL) is installed on the warm side of the construction, to prevent water vapour from getting into areas where it can cause problems. This vapour control layer should continue into window and door reveals where, commonly, there are reduced levels of insulation and a higher risk of greater temperature variation within materials. This option should always be used if there will not be adequate ventilation available to disperse water vapour in a restricted air space or if materials used within a construction do not promote the passage of water vapour, e.g. in long span roofs where a metal finish is used.

Condensation can also occur where two types of insulation are used to form the overall thickness required to meet thermal targets. If rigid and fibrous insulations are used together, the rigid insulation should be used on the warm side. If these are swapped over there is a risk that water vapour passing through a construction would be trapped when it meets the rigid insulation due to reduced vapour permeability of this material. There is also a similar issue when the insulation is split into two separate layers, such as those shown in the masonry wall with partial fill cavity insulation, where an outer layer which provides more insulation than the inner layer will assist in minimising condensation risk. BS 5250: 2002 - 'Code of practice for control of condensation in buildings' gives advice on this issue.

In all cases, a condensation risk analysis calculation should be carried out at the same time as the U-value calculation, to identify areas where condensation might form within the construction and allow amendment of proposals where this is assessed as problematic.

Guidance on carrying out an assessment of the risk of surface condensation, though determination of suitable minimum temperature factor can be found in chapter 4 of BRE IP 1/06 – ‘Assessing the effects of thermal bridging at junctions and around openings’. Reference should also be made to BS 5250: 2002 for general practical advice.

Reducing uncontrolled infiltration

Uncontrolled air infiltration can occur in many different locations for a variety of reasons. Common occurrences happen where junctions between construction elements are not well made or where holes drilled for fixings or services have not been fully filled.

Gaps and cracks can often develop when a building gradually dries out or settles over a number of years, creating new gaps where none were present upon completion of the original work. Accordingly, the manner in which junctions are sealed is very important with the specification of materials that are both durable and, where movement or shrinkage may occur, remain flexible.

The 2010 Technical Handbooks recommend that air tightness testing be carried out upon completion of the work to verify that the level of infiltration stated at design stage is achieved.

There are a number of strategies that can help to achieve a low level of uncontrolled infiltration.

The first principle is to make sure that there are no continuous air paths through a construction by defining a continuous air barrier within the construction of the building envelope. Key to this is determining the location and specification of materials which provide the air barrier and considering how continuity of the barrier will be achieved.

At design stage the position of the air barrier should be clearly identified on drawings. Critical to this is consideration of how the barrier will be maintained at junctions between elements, where two or more planes meet.

As with the design of thermal insulation, try to avoid any elements penetrating the materials forming the barrier layer. The location where services enter a building should also be considered at this stage, so that they can be clearly identified on drawings.

Holes or openings formed in wall, floor and roof constructions to allow for services to enter or leave a building should be neatly made and sealed up on site before any work to cover the air barrier is undertaken. Failure to do this could result in a risk that the locations may become inaccessible during later stages of construction. When services are fitted on site, as the air barrier is generally close to the internal finishes of walls and ceilings, there is generally a high risk of the air barrier being punctured unless measures are taken to prevent this (such as forming a dedicated service void).

- **Framed construction**

In framed construction, infiltration is usually addressed through use of an air barrier in the form of a membrane (usually also the internal vapour control layer) within the construction and through taping up all junctions and services penetrations through it. Whilst a vapour control layer controls the passage of moisture into or out of a construction, an air and vapour control layer will also address infiltration.

Such a dual-purpose barrier would not be employed where a construction is designed to be permeable or breathable. Construction solutions of this type allow moisture to pass through until it reaches a ventilated area and disperses. If there is no means by which any moisture passing through the construction can be removed by ventilation, then the vapour control layer approach should be used.

Additional thought should be given in designing for timber frame construction. When the timber frame dries out and shrinks slightly, details at window heads and at the wall/roof junction can then provide a direct air infiltration path. Any air tightness details should be designed to allow for such movement.

- **Masonry construction**

One common way to address air tightness in masonry construction is by applying a wet plaster finish or, if dry lining, a parge coat of mortar across the inside face of blockwork walling. This coating will fill any gaps in the construction, reducing direct air paths. This is particularly appropriate for use on internal separating walls where a render parge coat will help to prevent sound transmission as well as air infiltration paths.

Details at corner junctions should be carefully considered as these are the locations where cracks could occur if there is any movement of the building. This principle applies to the use of screeded floor finishes, as well as plaster on walls and ceilings.

In all cases, there should be an agreed site procedure confirming how any damage to the air tightness barrier (be it a membrane or other material) is to be repaired. An airtightness test will generally identify if any problems have been created by the services installation and remedial action should be taken where required. Information on the process undertaken when testing a building for airtightness can be found in the [ATTMA](#) publication 'Measuring Air Permeability of Building Envelopes'.

7. DESIGN PRINCIPLES - JUNCTIONS IN FRAMED CONSTRUCTION

The sections below give brief guidance notes on detailing issues necessary to minimise heat loss at specific junctions in timber and steel framed buildings. They will also serve to avoid surface condensation or mould growth at the junctions. The diagrams have been deliberately simplified to show only the information relevant to heat loss. The insulation layer is shown as:

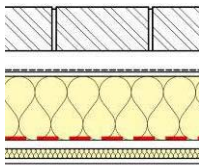

Fibrous insulation with little resistance to air movement or moisture transfer; rigid insulation with high resistance to air movement and moisture transfer shown to the inside of the timber frame construction. Where practical, these insulation zones should be continuous to minimise thermal bridging.

The red dotted line denotes line of vapour control layer which, in most construction solutions, will also act as the airtightness barrier.

Illustrative section through typical building

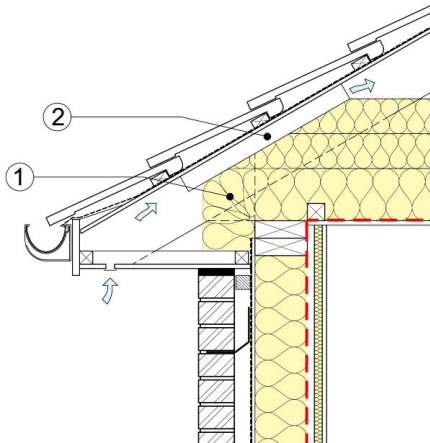

Pitched roof Eaves

1. Ensure the roof insulation overlaps the wall head.
2. If a ventilated loft is specified, ensure 25 mm clearance between insulation and sarking.

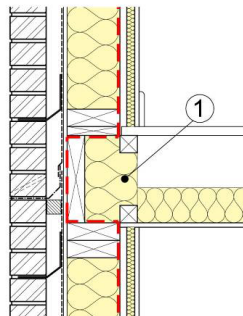

Intermediate floors

1. Include a strip of insulation around the perimeter, with thermal resistance of at least the same value as the external wall.

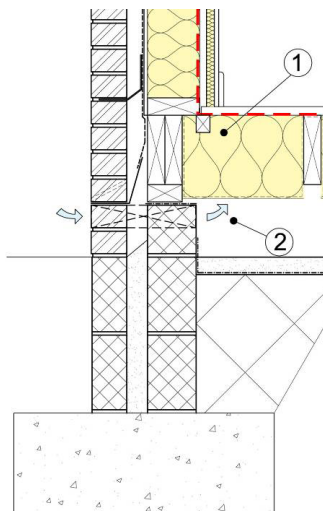

Wall to suspended ground floor

1. Ensure that the floor insulation is continued up to the wall base.
2. Ensure sub-floor ventilation is provided.

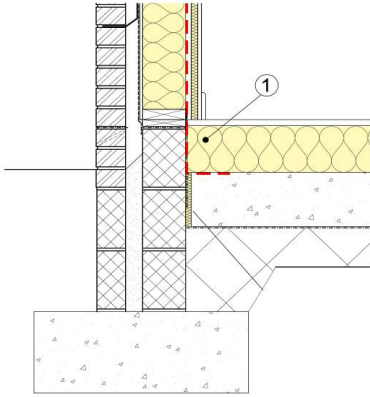

Wall to solid ground floor

1. Ensure that the floor insulation is continued up to the wall base.

Note – below floor level, low conductivity lightweight blockwork, which assists in reducing heat loss should be used only after satisfactory assessment of effect on noise performance at separating walls.

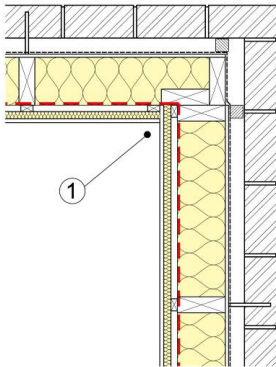

Corner

1. Ensure continuity of insulation around the corner. Tuck insulation around frame to avoid any gaps.

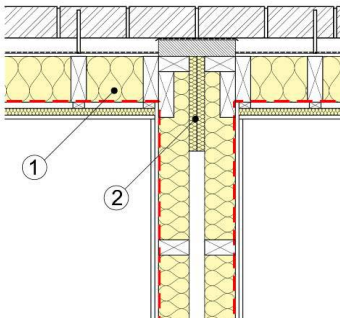

Party walls

1. Tuck insulation around the frame to avoid any gaps.
2. Fill any gaps in the frame with insulation.

Window lintel, sill and jamb

1. Ensure that the window frame sealed to the internal structure using a suitable tape or flexible sealant.
2. Use an insulated cavity closer will further reduce thermal bridging.

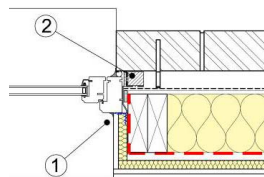
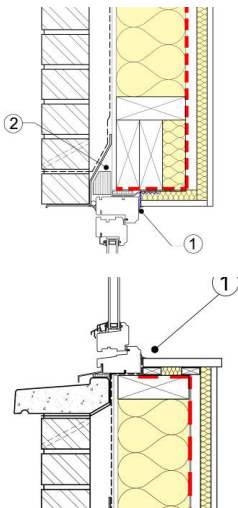

8. DESIGN PRINCIPLES - JUNCTIONS IN MASONRY CONSTRUCTION

The sections below give brief guidance notes on detailing issues necessary to minimise heat loss at specific junctions in masonry buildings. They will also serve to avoid surface condensation or mould growth at the junctions. The diagrams have been deliberately simplified to show only the information relevant to heat loss. The insulation layer is shown as:

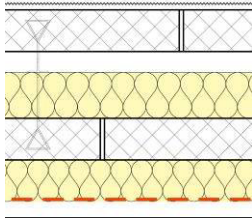

Fibrous insulation with little resistance to air movement or moisture transfer. These insulation zones should be continuous, where practicable, to prevent thermal bridging. The red dotted line denotes line of vapour control layer, which also acts as an airtightness barrier.

Illustrative section through typical building

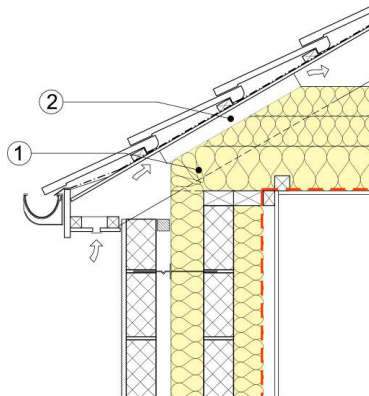

Pitched roof Eaves

1. Ensure the roof insulation fully overlaps the wall head.
2. If a ventilated loft is specified, maintain at least 25 mm clearance between insulation and sarking.

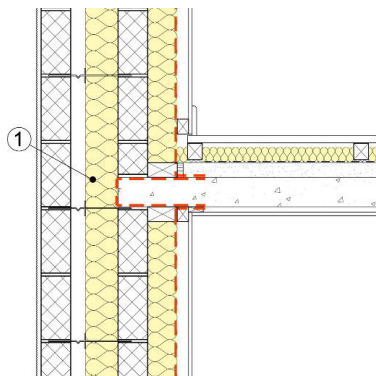

Intermediate floors

1. Ensure the cavity wall insulation is continuous across the end of any built-in concrete floor slab.

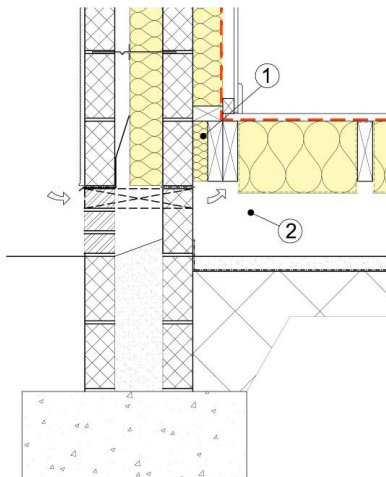

Wall to suspended ground floor

1. Ensure that a strip of insulation is installed between the joists and the masonry wall.
2. Ensure sub-floor ventilation is provided.

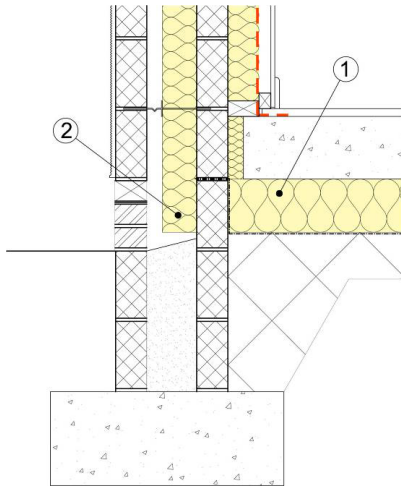

Wall to solid ground floor

1. Ensure that the floor insulation is continued up to the wall base.
2. Ensure that the cavity wall insulation covers the end of the insulation at floor level.

Note – below floor level, low conductivity lightweight blockwork, which assists in reducing heat loss should be used only after satisfactory assessment of effect on noise performance at separating walls.

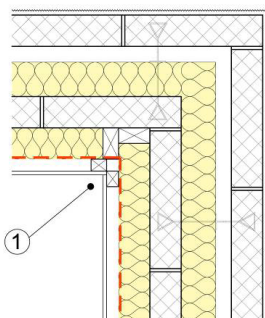

Corner

1. Ensure continuity of insulation around the corner. Tuck insulation around frame to avoid any gaps.

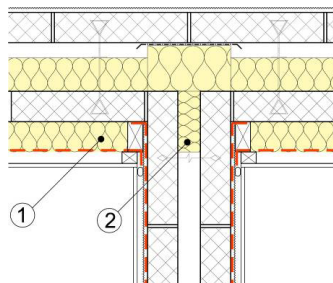

Party walls

1. Tuck insulation into corners to avoid any gaps.
2. Fill any gaps in the frame with insulation.

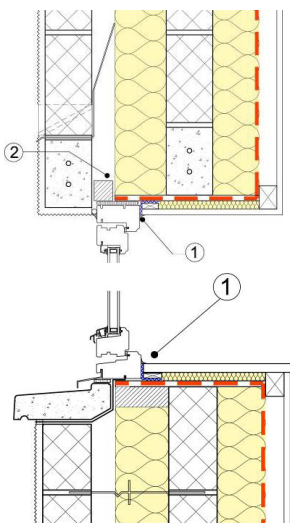

Window lintel, sill and jamb

1. Ensure that the window frame sealed to the internal structure using a suitable tape or flexible sealant.
2. Use an insulated cavity closer will further reduce thermal bridging.

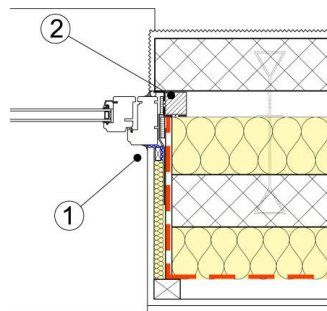

9. DESIGN TO LIMIT INFILTRATION & INTERSTITIAL CONDENSATION

Introduction

Energy losses from a building due to uncontrolled infiltration of air through fabric can be minimised by the definition and construction of a defined airtight layer between the occupied conditioned internal space and the external environment.

A means of preventing or limiting air infiltration should then be considered at every junction or penetration of this barrier. Particular care on site should be paid to:

- Joints between structural components e.g. wall to floors;
- Joints around components and opening within walls; and
- Service penetrations – plumbing, electrical and ventilation.

Forming the airtight layer at or close to the inside of the building insulation envelope will also prevent the movement of warm moist air into the structure and minimise the risk of interstitial condensation.

Design strategy - General

In considering the strategy to be adopted to limit infiltration, the following points should be considered;

- whilst not always an option, it is recommended that any defined airtight layer does not rely solely upon the integrity of final finishes as these can both be subject to mechanical damage in use and also may make remedial work in the event of a failed airtightness test more difficult.
- a condensation risk analysis should always be carried out on any proposed design details before finalising the construction information.
- breathing wall and roof constructions can be used but care has to be taken to ensure that the passage of water vapour through the construction is not stopped by the use of material that is not sufficiently vapour permeable. The general principle is that any materials used on the warm side of any insulation in the construction (i.e. any membranes and the internal wall finishes) should have a significantly greater vapour resistance than any construction components used in the cold side of the construction (see guidance in BS 5250:2002 for more information). In the case of breathing wall and roof constructions, the membrane used on the internal side of the wall or roof construction should be vapour permeable, regardless of their operation as an air barrier.

In developing proposals, the following points should be borne in mind:

- ensure that junctions around window frames are sealed against the building superstructure before applying the internal finishes.
- ensure that the joints in any vapour control layer (VCL) acting as an air barrier within a wall or ceiling are lapped (membrane) or tightly butted (rigid material) and are then properly sealed.
- ensure that a VCL or air barrier within a wall is sealed both to the ceiling and floor VCL, maintaining continuity between vertical and horizontal planes.
- close any vertical ducts at the top and bottom where they meet the air barrier (e.g. boxing around soil vent pipes).

- select the appropriate sealant or gap filler for the size of gap and degree of movement anticipated. Avoid specification and use of materials that will degrade or lose performance over time (e.g. some types of mastic).

Design strategy - Masonry Construction

- If plasterboard finish fixed on plaster dabs is to be used as the internal finish, this should not be relied upon solely to provide an air barrier. Apply a parge coat of render to the inside leaf of the masonry walls to create an air tight barrier.
- Ensure continuous ribbons of adhesive are used to fix dry lining at perimeters of external walls, openings, and services on external walls. Seal under skirting boards where dry lining is used, or on suspended floors. The importance of good sealing of dry lining needs to be stressed, as poor installation can affect the overall infiltration rate achieved.
- To minimise the need for packing and sealing, use joist hangers to support floor joists rather than building timber into masonry. Check continuity of air tightness barrier and seal up any gaps before installing joists.
- If insulation is used in both the cavity and on the internal face of the inner leaf to achieve the required U-value, ensure that the insulation in the cavity has an equal or greater thermal resistance (R) than the insulation used on the internal face. This will reduce the potential for interstitial condensation within the inner leaf.

Design strategy - Timber or Metal Frame

- Ensure that all joints between sheets of plasterboard are taped and, if possible, fixed against a timber batten or stud.
- Ensure DPCs are turned up behind sole plates and lap with vapour control layers; alternatively seal with mastic or a gasket between the DPC and sole plate.
- Place bead of mastic on timber floor deck before positioning wall panels (timber ground floors and intermediate floors).
- Ensure that there are no gaps between wall and floor panels.
- Ensure that insulation is tightly fitted between studs, without over-compressing, leaving no gaps.
- If a steel frame system is used to provide the construction of the inner leaf of an external wall, use insulated sheathing boards on the cavity side of the frame, to prevent condensation which might arise from a reduced surface temperature on metal elements.
- All joints between rigid insulation boards should be lapped or sealed with tape.
- Ensure 'sheet' vapour control layers are properly lapped at junctions; always return vapour control layers into door and window reveals, head and sills.
- If the vapour control layer is also the air tightness barrier, ensure that all junctions are taped, including junctions with floor and ceiling constructions.
- Fill all gaps around window and door openings with a compressible filler, to allow for possible movement in the frame.
- If no services void is used in the external wall construction, cut vapour control layers tight to electrical outlets and seal at piped service penetrations (with tape or sealant as appropriate).
- Ensure all breather membranes overlap each other and are stapled in place.

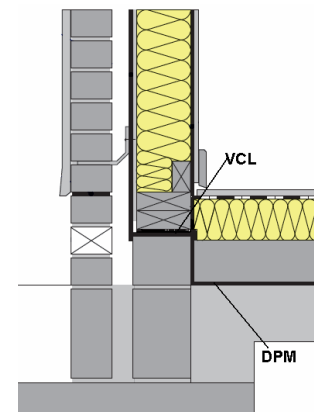

- If separate layers of insulation are used within the frame and as part of the internal finishes of the external wall to achieve the required U-value, ensure that the insulation within the frame has an equal or greater thermal resistance (R) than the insulation used on the internal face. This will reduce the potential for interstitial condensation within the frame.

Specific comment on particular building components

- **Extract fans** - Termination of extract fan ducts should be installed and sealed to prevent air infiltration occurring through plasterboard finishes. Where appropriate a continuous ribbon of adhesive should be installed around the penetration. Where possible the ducts should also be sealed to any masonry inner leaf. Extract fans may also be fitted with external flaps to minimise air infiltration through the unit.
- **Ceilings** - There can be substantial problems of air infiltration through ceilings, from penetrations that breach the plasterboard, such as an access hatch, plumbing, electric light fittings and recessed downlighters. These should only be allowed to penetrate the primary air barrier if the units are of an air sealed type or if a further secondary air barrier is formed beyond. Infiltration of warm, moist air can cause serious condensation problems in cold pitched roofs as well as being a significant source of heat loss. Proprietary products are available that can be used to seal many of these penetrations. Detailed guidance on achieving airtight ceilings is given in BS 9250: 2007 - 'Code of practice for design of the airtightness of ceilings in pitched roofs'.
- **Dormer windows** - Timber-to-timber junctions around rooflights have often been found to permit the ingress of air unless there is (a) a mastic or silicone seal applied or (b) an effective airtight membrane sealing to the rooflight frame behind the surface finishes. Plasterboard butting up to timber rooflight frames, even when inserted into a specially sized groove in the rooflight frame, similarly has been typically found not to provide an air tight seal. Care should be taken to ensure that the linings form a continuous air barrier and are fully sealed to the window frames.
- **Loft hatches** - Considerable air leakage has been found to occur around both proprietary and site-constructed loft hatches, with a large difference between the best and worst examples. Because loft hatches are often immediately above one of the warmest parts of a dwelling, leakage around them will allow warm air to escape into the loft space and can generate a significant stack effect. This causes cold air to be sucked into the building at low level, with consequent discomfort to the occupants and users of the building.

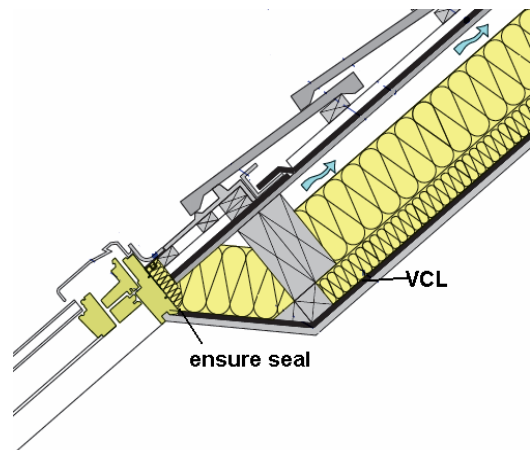

Even the most well regarded proprietary loft hatches can have considerable leakage if poorly installed. It is possible to construct a very airtight hatch on site, typically with some mastic sealing between the frame and the plasterboard ceiling, using compressible closed-cell foam insulation between the top of the lip to the frame and the underside of the hatch and pulled tight using small bolts fitted to the underside of the hatch.

Workmanship

No matter how good and simple the design of a building detail, problems can still arise from poor workmanship on site. Issues that need attention include:

- **Poorly positioned cavity insulation** - cavity wall insulation should be installed neatly, both tight against the outer face of the inner leaf and with tight joints between boards/batts. This will prevent air circulation between the block and insulation or through the insulation layer into the cavity, reducing the performance of the insulation layer.
- **Debris in the cavity** - all debris, including mortar droppings should be cleared from the cavity as work progresses to prevent cold bridging and possible water penetration occurring between the inner and outer leaf. Check the cavity for mortar snots or other irregularities at least once per half-storey lift. Use of cavity boards will assist in minimising debris.
- **Insulation cut short** - ensure that cavity insulation is cut accurately to suit to avoid gaps, with boards/batts that tightly butt against each other and against surrounding cavity closers and any loose fill insulation.
- **Seal between the DPM in the floor and the air barrier in the walls** – this is more difficult at corners, where multiple planes meet and the use of appropriately shaped pre-formed sections of rigid DPM may be useful in avoiding the difficulties experienced in trying to make airtight overlaps and folds in materials. It is essential to ensure that these are correctly installed, since they can easily be damaged if they have to be moved or repositioned on site.
- **Seal between the DPC and the underside of profiled door thresholds** - this has often proved problematic in practice, with movement and damage on site often compromising this seal before the building is complete. It is essential that door thresholds are robustly supported during construction and that voids are fully filled and sealed.
- **Service penetrations** - service penetrations should be core drilled to minimise damage to the insulation layer and facilitate remedial air sealing. Any damage caused to the insulation layer by penetrations through the air barrier should be made good following their installation. This can be achieved by filling any large gaps with loose fibrous insulation, expanding foam insulation and then sealing with a thin mastic fillet. Locations includes behind bath panels, shower trays, kitchen units and into service shafts.

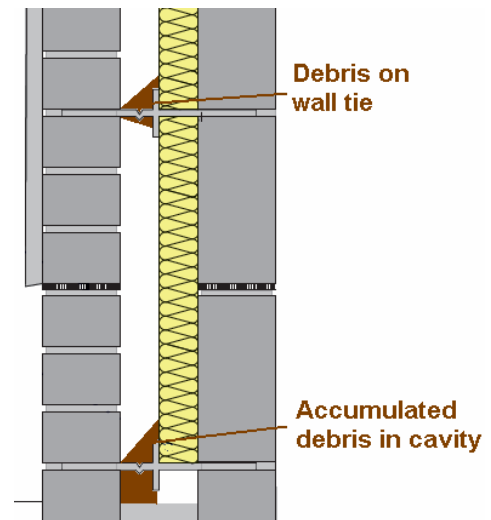

An example of an alternative approach is the 'casting in' of suitably sized pipes and flexible trunking through the concrete floor slab at an early stage. This will make it easier to achieve an effective and robust airtight seal at the junctions of the service penetrations and at any concrete infill.

Close any vertical service ducts at the top and bottom where they meet the air barrier (e.g. boxing around soil vent pipes). Seal any service penetrations throughout the air barrier and select the appropriate sealant or gap filler for the size of gap and degree of movement.

- **Socket outlet /switch plates** – preference should be given to solutions where services are installed in a manner which does not interrupt the air barrier, such as through use of a dedicated service void.

Where the air barrier is formed by a plasterboard lining it is recommended that a continuous ribbon of adhesive is applied around the hole prior to installing the plasterboard. This will reduce air infiltration through the sockets/switches into the void beyond. Proprietary gasketed socket boxes and membranes are also available where required.

Effective and robust sealing of penetrations through plasterboard is greatly helped by the use of timber pattresses or similar behind the plasterboard in appropriate locations, enabling the use of sealing grommets or tapes or, where a lesser standard of airtightness is required, providing a rigid substrate for mastic sealing around the cables, pipes or other penetrations through the plasterboard.

- **Stairs** - plaster finishes are typically omitted from voids below staircases. Similarly, finishing of board materials may be overlooked in such locations. Air infiltration may then occur through mortar joints in poor quality masonry into the externally ventilated wall cavities. For masonry walls, plaster finishes should be installed below stairs or a thin render/parge coat should be applied to the surface of the masonry.

Properties of differing insulation materials

Whilst there are many ways of insulating, the most common types of insulation material are:

- fibrous insulation batts or rolls, such as mineral wool, glass fibre, wood fibre, hemp or wool, and sprayed or blown cellulose. This is relatively open to air and water vapour movement but can easily be installed to fill any gaps completely. Insulation should be securely fixed in place or, if sprayed or blown fibres are used, contained within a defined zone; and
- rigid plastic foam, which comes in boards. This is air and vapour tight, but has to be cut to shape carefully to fit between studs or rafters without leaving gaps. If this is not possible, all gaps between insulation and adjacent structure should be infilled.

Where different types of insulation are used within a construction, it is recommended that the insulation nearest to the outer surface of the construction be the least resistant to the passage of water vapour. This is to reduce the possibility of condensation forming in between the insulation layers. For example, where mineral wool is used in conjunction with polystyrene board, the mineral wool should be the outer layer. Where it is essential that the outer layer of insulation has a higher vapour resistivity than the inner layer then condensation risk analysis should always be carried out.

Ventilation of cavities

Many walls, floors or roofs contain air cavities which extend over the whole area of the building but, except for pitched roofs with a horizontal ceiling, are generally narrow (50–100 mm wide) and inaccessible.

Outside of the insulation layer, movement of external air through a cavity will greatly reduce the risk of condensation whilst having negligible effect on thermal performance. However, movement of external air through a cavity within or to the inside of the insulation layer will reduce the insulation value of the fabric due to heat loss from convection. Also any penetration of air from the inside the building into a cavity outside the insulation can result in interstitial condensation.

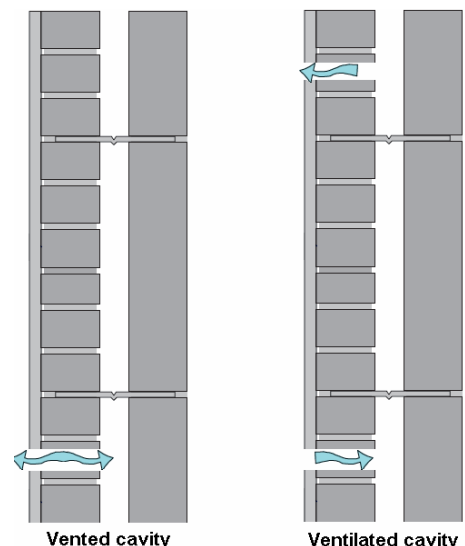

It is useful to distinguish between the need for 'vented' and 'ventilated' cavities:

- 'vented' cavity, has openings at only one end; while there is no through air flow temperature changes will cause air to move in and out removing water vapour. This will be sufficient in, for example, the cavity between the sheathing and cladding in a timber framed wall.
- 'ventilated' cavity, with openings at both ends allowing a through flow of air. This is necessary in, for example, a cold pitched roof with a high vapour resistance underlay.

Ventilating a cavity to the outside will lower its effective thermal resistance. BS EN ISO 6946: 2007 specifies the method for calculating this reduction in resistance as a function of the degree of ventilation.

Low Emissivity Materials

Most building materials have a surface emissivity close to 0.9. This means that they emit about 90% of the infra-red radiation that would be emitted by a perfect 'black body'. Some components, usually membranes or coatings on board materials, appear to have a shiny metallic finish and have a lower emissivity, possibly 0.2 or less. This will not affect the thermal performance of the component in itself, but will increase the effective thermal resistance of any air cavity adjacent to the low emissivity surface.

Rules for calculating the increased resistance as a function of emissivity are given in BS EN ISO 6946: 2007. The benefit of low emissivity will be less if the cavity is ventilated. It should be borne in mind that the emissivity of very low emissivity materials ($e < 0.2$) will tend to degrade with time due to the accumulation of dust and dirt.

Types of Building Membranes

The junction details in sections 1 to 5 illustrate the location and characteristics of the membranes related to their function in resisting the passage of water, water vapour or air. These characteristics are fundamental to the success of the construction and selection of the correct membrane should be made with care. There are three different types to be considered:

- **Vapour control layer (VCL)** - a material or construction with a defined vapour resistance. Commonly a thin sheet material, used to reduce the diffusion of water vapour generated within the building into the structure (and so reduce the risk of interstitial condensation) and to improve the airtightness of the building fabric, to limit uncontrolled ventilation and leakage of warm moist air into the structure.

In framed construction, it is common for the air and vapour control to be combined in a single membrane as an 'air and vapour control layer' (AVCL), with a vapour resistance of 200 - 250 MN·s/g or greater. Such a membrane is used to prevent the convective movement of air under the normal pressure differences found in buildings (note: in breathing wall or roof construction, these should be 'open diffusive', allowing the passage of water vapour through the membrane).

Typically this layer is provided on the inside face of the insulation in, timber or steel frame walls, rooms in roof spaces, flat roofs and it may be incorporated as an integral part of a proprietary wall lining board. A VCL incorrectly positioned on the cold side of insulation can cause severe interstitial condensation.

- **Roofing underlays** - should be used as: a primary protection to vulnerable roof construction materials from the harmful effects of precipitation during the construction process and after completion (for example the covering to a built-up felt flat roof directly above the insulation). Or as a secondary protection to vulnerable roof construction materials from the harmful effects of precipitation, for example as a roof tile underlay where the roof space is ventilated above the insulation. There are two types of roofing underlay:
 - High resistance (HR), with a vapour resistance of more than 0.25 MN-s/g. It is essential that, in a cold pitched roof with insulation on a horizontal the ceiling, there is ventilation below a HR underlay
 - Low resistance (LR) with a vapour resistance no more than 0.25 MN-s/g. It may not be necessary to ventilate a cold pitched roof below a LR underlay, where such material has third party certification for use in an unventilated roof, however, care must still be taken to limit the passage of water vapour through the ceiling.

- **'Breather' or vapour permeable membranes** - should be used as:
 - a primary protection to vulnerable construction materials from the harmful effects of precipitation during the construction process; and
 - as a secondary protection to vulnerable construction materials from the harmful effects of precipitation, throughout the life of the building; and
 - to allow water vapour to escape from vulnerable construction materials that would otherwise be entrapped due to lack of ventilation.

Typically this layer, which has a vapour resistance of not more than 0.6 MN-s/g, is provided on the outer face of the inner leaf of a timber frame wall. Some breather membranes have a low emissivity surface, which improves the thermal performance of the wall.

- **Air tightness membrane**

An airtightness membrane is used to prevent the convective movement of air under the normal pressure differences found in buildings. It may also double as a vapour control layer or be installed in locations where a degree of vapour permeability is not needed. Not all air barriers also allow passage of vapour, so it is essential to ensure that the correct material is specified for an intended use (see vapour control layer).

Any membrane or material used in a breathing construction should be open diffusive, i.e. allow the passage of water vapour.

APPENDIX 1 - DESIGN & CONSTRUCTION CHECKLISTS

Thermal Continuity Design Checklist

1	Determine how the insulation envelope is to be implemented – Consider overall strategy (materials, use of thermal mass, ‘sealed’ or breathable construction, construction sequencing, etc). Identify whether the insulation zone is or is not to allow water vapour to pass through	
2	Identify the thermal insulation zone and clearly mark on all plans and sections, provide clear performance specification for all materials.	
3	If a construction is to allow water vapour to pass through, ensure that the vapour permeability of elements increases from the inside of the construction to the outside. Seek specific advice on the location and permeability of any vapour membranes used in the construction	
4	If a construction is not to allow water vapour to pass through, use a vapour control barrier on the warm side of the insulation, close to the internal face of the construction	
5	Make sure that any water vapour passing through the construction will meet a well ventilated space that will allow vapour and any condensation to disperse	
6	Identify all the elements that cross through the insulation zone and find out if these can be removed. If they cannot and are elements repetitive, account for in the U-value calculation	
7	Make sure that insulation at the ground floor/roof and external wall overlap or abut where practical	
8	Make sure that all window and door openings that pass through the insulation zone have a continuous thermal barrier around the opening	
9	Identify the route of all incoming/outgoing services and how these are to be sealed where they pass through the insulation zone	

Thermal Bridging Design Checklist

1	Follow Items 1 - 9 on the thermal continuity design checklist	
2	Look at proposals for junctions in relation to advice within the ACD introduction and other recommended sources of information. Consider ease of construction of proposals	
3	Where bridging concerns identified, determine if the material, location or size of any bridging elements at junctions can be changed to improve thermal continuity	
4	Where element specification cannot be changed, check if the bridging element can be broken into two smaller elements and insulation introduced between them	
5	Determine psi values for the proposed junctions, to assess the additional heat loss arising from the construction of junctions and openings	

Air Tightness Design Checklist

1	Determine how the air tightness strategy is to be implemented - overlapping details, membrane/board/wet finishes, jointing and sealing junctions, durability of materials. If possible, involve testing organisation in development process.	
2	Identify the air tightness layer and clearly identify on all relevant plans and sections, provide clear performance specification for all materials.	
3	Identify all the elements that cross through the air tightness layer and find out if these can be removed or relocated	
4	Identify all incoming / outgoing services and how these are to be sealed where they pass through the air tightness layer. Consider creation of service void to reduce penetrations	
5	Confirm how any repairs to the air tightness layer are to be carried out	
6	Determine if any of the construction junctions are likely to be affected by movement over a period of time and consider specification of materials required to accommodate this movement	

APPENDIX 1 - DESIGN & CONSTRUCTION CHECKLISTS

Thermal Continuity Site Checklist

1	Identify who will be responsible for coordinating and inspecting installation on site. Discuss any specific issues, agree any monitoring and reporting regime tied into periodic inspection	
	Discuss and agree construction sequencing (example - installing insulation in the roof space before the roof finishes to allow for correct overlap of insulation at eaves or sequence insulation to create a defined perimeter edge against which the roof insulation can be fitted)	
2	Check that the insulation specified has been delivered and check that any "or equal" substitute specification has the same performance	
3	Store insulation in a safe place on site and check that none is damaged before installation	
4	Make sure that junctions between insulation boards are tightly formed	
5	Make sure that any gaps in the insulation zone around services penetrations are sealed before continuing with the construction sequence	
6	Install all edge insulation around the perimeter of a floor before applying the floor finishes. This also applies to a suspended timber floor	
7	In the roof construction, fit insulation tightly between joists, providing support and temporary protection, to prevent damage to the insulation	
9	Check that all ventilation air paths are clear	
10	Make sure that all secondary insulation is fitted into awkward junctions	
11	Make sure that thermal cavity barriers are fitted around all sides of window and door openings	

Thermal Bridging Site Checklist

1	Follow Items 1 - 11 on the thermal continuity design checklist	
2	Check that the external wall/floor junctions are being built in accordance with the construction details and that no insulation has been damaged or omitted	
3	Check that wall and floor insulation is installed tightly against the building structure and that there are no gaps between boards/batts/joists	
4	Make sure that no debris is in a cavity wall construction and that all mortar droppings are cleared off from wall ties	
5	Check that all cavity ventilators, trays and barriers have been installed	
6	Check that the external wall/roof insulation meets with no gaps	
7	Check that any insulation fitted around steel structure has been fitted correctly and that no additional thermal bridging has been created during the site installation of the structure	
8	When windows and doors are fitted, check that any gaps left to allow installation have been fully filled. Note: for timber frame constructions, this may require that compressible fillers are used	
9	Check if any second fix services have affected the insulation zone	

Air Tightness Site Checklist

1	Make sure that the site operatives understand the air tightness details and that the correct materials are provided. If possible, involve testing organisation in these discussions	
2	Follow all the points on the thermal continuity and thermal bridging lists	
3	Check that there are no continuous air paths have been created during the site installation e.g. at windows, doors, floor junctions, roof junctions and at services. Note: this to be a visual inspection on site until the first air tightness test is carried out	
4	Check that, where designed, all taped junctions at boards, membranes, insulation, etc. have been installed	
5	Check if any second fix services have affected the air tightness layer	
6	Check that any remedial work required as a result of site damage has been carried out before finishes are installed	
7	Carry out initial air tightness testing (dependent upon specification of air barrier, this may be before final finishes are applied)	
8	If testing identifies performance issues, seek advice on appropriate remedial work in discussion with employer's agents and, ideally, testers who should provide both analysis and advice	
9	Retest only once issues fully investigated and remedial work agreed and carried out	

APPENDIX 2 - VALUES USED IN PSI CALCULATIONS

Thermal Conductivity (lambda - λ)

Thermal conductivity is a measure of a material's ability to conduct heat. It is measured in W/mK and is the quantity of heat (in Watts) which will pass through one square metre of the material 1 metre thick for each degree difference in temperature between one side of the material and the other. Any quoted thermal conductivity of a given material is, therefore, independent of its thickness.

Material	λ - values used in calculations (W/mK)
Plasterboard	0.21
Insulation (generic)	0.04
Plywood sheathing	0.13
Brick outer leaf	0.77
Mineral wool insulation	0.044
Concrete block (dense) protected	1.13
Concrete block (lightweight, high strength)	0.19
Timber frame	0.13
Concrete floor beam	2.3
Concrete screed	1.15
Render (cement / sand)	1.0
Gypsum plaster (1000 kg/m ³)	0.4
Concrete roof tiles	1.5
EPDM membrane	0.25
Timber battens	0.13
Timber flooring	0.13
Chipboard	0.13
Floor joists	0.13
Aluminium	160
Steel	50
Stainless steel	17
Glass	1
Sarking felt	0.23
Insulation board (replacing sarking/sheathing)	0.022

Notes: Values are taken from the BRE U-value calculator tool unless otherwise stated.
Values have been checked against data from the CIBSE A Guide.

APPENDIX 3 – TEMPERATURE FACTOR FOR DETAILS

As noted in Chapter 3, any details published with calculated psi values should also provide evidence that a satisfactory assessment of the risk of surface condensation has been carried out. The following table gives the temperature factor, f_{Rsi} , for published junctions.

Note: for conditions generally found in dwellings, this figure should be not less than 0.75.

Detail	f_{Rsi}	Detail	f_{Rsi}	Detail	f_{Rsi}	Detail	f_{Rsi}	Detail	f_{Rsi}
1.01	0.95	2.01	0.94	3.01	0.90	4.01	0.93	5.01 head	0.82
1.02	0.92	2.02	0.91	3.02	0.95	4.02	0.91	5.01 cill	0.91
1.03	0.93	2.03	0.93	3.03	0.92	4.03	0.93	5.01 jamb	0.84
1.04	0.96	2.04	0.95	3.04	0.94	4.04	0.94	5.02 head	0.81
1.05	0.92	2.05	0.93	3.05	0.93	4.05	0.93	5.02 cill	0.91
1.06	0.95	2.06	0.93	3.06	0.91	4.06	0.88	5.02 jamb	0.85
1.07	0.88	2.07	0.91	3.07	0.92	4.07	0.92	5.03	0.94
1.08	0.93	2.08	0.79	3.08	0.77	4.08	0.93	5.04 eaves	0.90
1.09 jamb	0.90	2.09 jamb	0.81	3.09 jamb	0.89	4.09 jamb	0.91	5.04 valley	0.95
1.09 cill	0.86	2.09 cill	0.81	3.09 cill	0.76	4.09 cill	0.92	5.05 eaves	0.98
1.10	0.87	2.10	0.91	3.10	0.87	4.10	0.95	5.05 valley	0.95
1.11	0.91	2.11	0.90	3.11	0.85	4.11	0.87	5.06	0.73
1.12	0.86	2.12	0.90	3.12	0.92	4.12	0.89	5.07	0.75
1.13	0.97	2.13	0.95	3.13	0.91	4.13	0.92	5.08	0.74
1.14	0.93	2.14	0.93	3.14	0.93	4.14	0.93	5.09	*
1.15	0.96	2.15	0.95	3.15	0.95	4.15	0.93	5.10 wall	*
1.16	0.76	2.16	0.80	3.16	0.95	4.16	0.80	5.10 roof	*
1.17	0.75	2.17	0.84	3.17	0.86	4.17	0.86	5.11	*
1.18	0.77	2.18	0.75	3.18	0.94	4.18	0.78	5.12	0.98
1.19	0.94	2.19	0.83	3.19	0.94	4.19	0.97		
1.20	0.88	2.20	0.87	3.20	0.94	4.20	0.97		
1.21	0.95	2.21	0.91	3.21	0.98	4.21	0.77		
1.22	0.95	2.22	0.92	3.22	0.92	4.22	0.87		
1.23	0.95	2.23	0.92	3.23	0.88	4.23	0.85		
1.24	0.97	2.24	0.97	3.24	0.96	4.24	0.94		
						4.25	0.93		
						4.26	0.91		
						4.27	0.93		
						4.28	0.94		

* detail relates to point thermal transmittance

APPENDIX 4 – FURTHER INFORMATION

Referred documents

- BS EN ISO 6946: 2007 - 'Building components and building elements – Thermal resistance and thermal transmittance - Calculation method (ISO 6946:2007)'
- BS EN ISO 10077-1:2006 – 'Thermal performance of windows, doors and shutters. Calculation of thermal transmittance. General'
- BS EN ISO 10077-2:2003 – 'Thermal performance of windows, doors and shutters. Calculation of thermal transmittance. Numerical method for frames'
- BS EN ISO 10211: 2007 – 'Thermal bridges in building construction - Heat flows and surface temperatures - Detailed calculations (ISO 10211:2007)'
- BS EN ISO 12567-2:2005 – 'Thermal performance of windows and doors. Determination of thermal transmittance by hot box method. Roof windows and other projecting windows'
- BS EN ISO 13370:2007 – 'Thermal performance of buildings. Heat transfer via the ground. Calculation methods'
- BS EN ISO 13788: 2004, incorporating Corrigendum No. 1 – 'Hygrothermal performance of building components and building elements – Internal surface temperature to avoid critical surface humidity and interstitial condensation – Calculation methods'

Further reading

Limiting heat loss and linear thermal bridging

- BR 443 – 'Conventions for U-value calculations'
- [SAP 2009](#) (for linear thermal bridging, see Appendix K)
- BRE publication IP 1/06 - 'Assessing the effects of thermal bridging at junctions and around openings' (BRE Press, 2006)
- BRE publication BR 497 - 'Conventions for Calculating Linear Thermal Transmittance and Temperature Factors' (BRE Press, 2007)

Limiting infiltration

- NH16 – 'A practical guide to building airtight dwellings' (NHBC Foundation, 2009) - <http://www.nhbcfoundation.org/>
- SEDA Design Guide 2: 'Design and Detailing for Air Tightness' - www.seda.uk.net
- [ATTMA](#) publications TSL1 & 2 - 'Measuring Air Permeability of Building Envelopes'.

Avoiding condensation

- BR 262 - 'Thermal insulation: avoiding risks' (BRE Press, 2004)
- BS 5250: 2002 - 'Code of practice for control of condensation in buildings'
- BS 9250: 2007 - 'Code of practice for design of the airtightness of ceilings in pitched roofs'
- BR 466 - 'Understanding dampness - effects, causes, diagnosis and remedies' (BRE Press, 2004)

Other useful sources of information

- EST CE302 – ‘Enhanced Construction Details: thermal bridging and airtightness’ - www.energysavingtrust.org.uk.
- The AECB CarbonLite Programme, Volumes 1-5 - www.aecb.net & www.carbonlite.org.uk/carbonlite
- Accredited Construction Details (under review) – Communities & Local Government - <http://www.planningportal.gov.uk/buildingregulations/>
- “Limiting Thermal Bridging and Air Infiltration – Acceptable Construction Details” - Environment, Heritage and Local Government Department, Ireland - www.environ.ie



The Scottish
Government